

## BUKTI KORESPONDENSI

Nama : Dr. Elanda Fikri, S.KM., M.Kes  
NIP : 198903112015031002  
NIDN : 4011038901  
Jabatan : Lektor Kepala  
Unit Kerja : Poltekkes Kemenkes Bandung

<p>Jurnal internasional bereputasi (terindeks pada database internasional bereputasi dan berfaktor dampak)</p> <p>Penulis pertama : (60% x40=24)</p>	<p>Total coliform reduction in drinking water based on variations in reverse osmosis membrane pressure</p>	<p>Global Nest Journal, Volume 24, Issue 4, 2022, Pages 569-575, Penulis pertama, ISSN: 17907632, DOI: 10.30955/gnj.004458, Publisher: Global NEST. SCOPUS Q3 (<b>Fikri E</b>, Ramdhanny F.M., Nurhayati A, and Amar Sharaf Eldin K.)</p> <p>Link DOI : <a href="https://doi.org/10.30955/gnj.004458">https://doi.org/10.30955/gnj.004458</a></p> <p>Link WEB : <a href="https://journal.gnest.org/publication/gnest_04458">https://journal.gnest.org/publication/gnest_04458</a></p> <p>URL DOKUMEN : <a href="https://journal.gnest.org/sites/default/files/Submissions/gnest_04458/gnest_04458_published.pdf">https://journal.gnest.org/sites/default/files/Submissions/gnest_04458/gnest_04458_published.pdf</a></p> <p>URL H-INDEKS/SJR: <a href="https://www.scimagojr.com/journalsearch.php?q=19700174610&amp;tip=sid&amp;clean=0">https://www.scimagojr.com/journalsearch.php?q=19700174610&amp;tip=sid&amp;clean=0</a></p> <p>URL SIMILARITY : <a href="http://repo.poltekkesbandung.ac.id/7052/1/Total%20Coliform%20Reduction%20in%20Drinking%20Water%20Based%20on%20Variations%20in%20Reverse%20Osmosis%20Membrane%20Pressure.pdf">http://repo.poltekkesbandung.ac.id/7052/1/Total%20Coliform%20Reduction%20in%20Drinking%20Water%20Based%20on%20Variations%20in%20Reverse%20Osmosis%20Membrane%20Pressure.pdf</a></p>
--	--	---

## SUBMIT (5 September 2022)

[Global NEST Journal] Manuscript ID gnest\_04458 - Submission notification Yahoo/Email M... ☆

 **gnest@gnest.org**  
Kepada: Dr. Elanda Fikri Sen, 5 Sep 2022 jam 22.47 ☆

Dear Dr. Elanda Fikri,

Your paper entitled "Total Coliform Reduction in Drinking Water Based on Variations in Reverse Osmosis Membrane Pressure" has been successfully submitted online.

Your manuscript ID is gnest\_04458  
Paper Topic: Water and Wastewater Treatment

Please mention the above manuscript ID in all future correspondence or when contacting the office for questions. If there are any changes in your affiliation, postal or e-mail address, please log in to <http://journal.gnest.org> and edit your user information as appropriate.

Your manuscript will be considered by the editor and, if appropriate, will be reviewed by a group of referees. An email message will be sent to you by the editor when the reviewers provide their comments.

You can also view the status of your paper at any time by checking «My papers» section after logging in to <http://journal.gnest.org>.

Thank you for submitting your paper to Global NEST Journal .

Yours sincerely,  
Global NEST Journal Editorial Office



## MENDAPATKAN REVIEW (11 SEPTEMBER 2022)

[Global NEST Journal] New decision has been made Yahoo/Email M... ☆

 **gnest@gnest.org**  
Kepada: Dr. Elanda Fikri Min, 11 Sep 2022 jam 20.01 ☆

Dear Dr. Elanda Fikri

On behalf of the Global NEST Journal Editorial Office, we thank you for the submission of your manuscript:

Ref No: gnest\_04458  
Title: Total Coliform Reduction in Drinking Water Based on Variations in Reverse Osmosis Membrane Pressure

The reviewers suggested that your manuscript requires some modifications, which you can see in detail, after logging in to the website, by following the link

<https://journal.gnest.org/journal/cmp/author>

You are kindly requested to modify your manuscript according to the reviewers' suggestions. The revised version should be submitted to GNEST Journal through the online system.

Please use the "track changes" option, provided by MS Word, to indicate all changes made and include a point-by-point summary of your response to the referees' comments. This should have the format of comment-response, comment-response, etc.

Once you have revised your manuscript, go to [journal.gnest.org](http://journal.gnest.org) and login to your <https://journal.gnest.org/journal/cmp/author> . Click on "Create Revision" located under the field "Operations" . Then, follow the steps for resubmitting your manuscript.

Please note that resubmitting your manuscript does not guarantee eventual acceptance and that your resubmission will be subject to re-review before a decision is provided.

Yours sincerely,  
Global NEST Journal Editorial Office

# Total Coliform Reduction in Drinking Water Based on Variations in Reverse Osmosis Membrane Pressure

▼ [Current Version](#)

Paper ID: gnest\_04458

Graphical abstract:

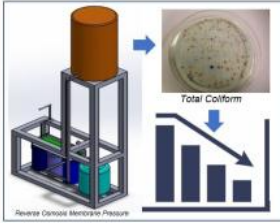

Topic: Water and Wastewater Treatment

Corresponding Author: Elanda Fikri

File: [gnest\\_04458\\_ver2.docx](#)

Authors:

Fikri E. Ramdhanny FM. Nurhayati A. Khair ASE

Keywords: Coliform, Reverse Osmosis Membrane, Variation of Water Pressure

Abstract:

Water is the most important substance. Drinking water in the industry comes from raw water and is treated through a heating process. The results of laboratory tests on raw water used for drinking water are 41 MPN/100ml, so it is necessary to process raw water into drinking water using Reverse Osmosis (RO) membrane technology. The purpose of this study is to determine the difference in the decrease in the total amount of Coliform in drinking water based on variations in water pressure on the Reverse Osmosis membrane in the canteen of X Industry. This type of research is an experiment with the design used is pre-test post-test without control, the sampling technique used is grab sampling, and the total sample is 36 samples with a volume of 3600 ml. The decrease in the total number of Coliforms was analyzed using univariate and bivariate tests. The results of total Coliform in drinking water after treatment with Reverse Osmosis membranes are the average results for a pressure of 1 bar is 0 MPN/100 ml, a pressure of 1.5 bar is 2.81 MPN/100 ml, and a pressure of 2 bar is 5.3 MPN/100 ml. This study concludes that there is a difference between the pressure of 1 bar, 1.5 bar, and 2 bar on the decrease in the total Coliform content in the canteen of X Industry with a p-value of 0.001, and the most effective pressure to reduce total coliform in drinking water in the canteen of X Industry is a pressure of 1 bar with a 100% percentage. Suggestions for further research to carry out the saturated condition of the Reverse Osmosis membrane.

Comments:

Dear Editor, I attached the revised results and adjusted it according to the reviewer's comments. The comment-response table (point by point) is attached at the end of the paper. I hope to be published in this journal soon. Thank you

# Total Coliform Reduction in Drinking Water Based on Variations in Reverse Osmosis Membrane Pressure

Elanda Fikri<sup>1,4</sup>, Feisal Muhammad Ramdhanny<sup>2</sup>, Ati Nurhayati<sup>3</sup>, Amar Sharaf Eldin K<sup>5</sup>

<sup>1,2,3</sup>Department of Environmental Health, Bandung Health Polytechnic, North Cimahi, Indonesia, 40514

<sup>4</sup>Center of Excellence, Bandung Health Polytechnic, Jalan Pajajaran 56, Bandung, Indonesia, 40171

<sup>5</sup>Omdurman Islamic University, Geography Department, Omdurman City – Sudan

\*Corresponding author email: elandafikri@yahoo.com

## GRAPHICAL ABSTRACT

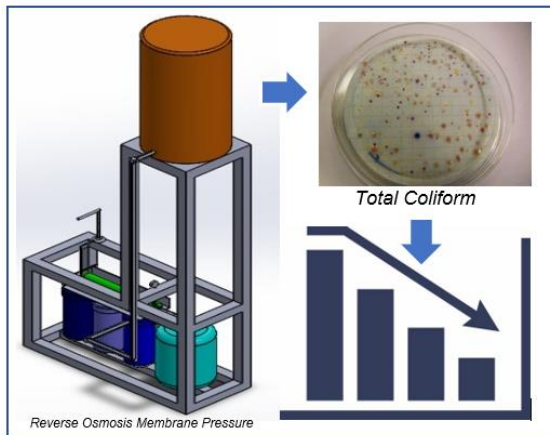

## ABSTRACT

Water is the most important substance. Drinking water in the industry comes from raw water and is treated through a heating process. The results of laboratory tests on raw water used for drinking water are 41 MPN/100ml, so it is necessary to process raw water into drinking water using Reverse Osmosis (RO) membrane technology. The purpose of this study is to determine the difference in the decrease in the total amount of Coliform in drinking water based on variations in water pressure on the Reverse Osmosis membrane in the canteen of X Industry. This type of research is an experiment with the design used is pre-test post-test without control, the sampling technique used is grab sampling, and the total

sample is 36 samples with a volume of 3600 ml. The decrease in the total number of Coliforms was analyzed using univariate and bivariate tests. The results of total Coliform in drinking water after treatment with Reverse Osmosis membranes are the average results for a pressure of 1 bar is 0 MPN/100 ml, a pressure of 1.5 bar is 2.81 MPN/100 ml, and a pressure of 2 bar is 5.3 MPN/100 ml. This study concludes that there is a difference between the pressure of 1 bar, 1.5 bar, and 2 bar on the decrease in the total Coliform content in the canteen of X Industry with a p-value of 0.001, and the most effective pressure to reduce total coliform in drinking water in the canteen of X Industry is a pressure of 1 bar with a 100% percentage. Suggestions for further research to carry out the saturated condition of the Reverse Osmosis membrane.

**Keywords :** Coliform, Reverse Osmosis Membrane, Variation of Water Pressure

## **INTRODUCTION**

Drinking water is household drinking water that goes through a treatment process or without a treatment process that meets health requirements and can be consumed immediately (Gadgil, 1998; Treacy, 2019). Provision of drinking water at X Industry comes from a drilled well, of which there are 4 spots in X Industry and all of them have been licensed and certified. Clean water from the wellbore is drained into the treatment before distribution. Drinking water used in X Industry comes from clean water and only performs simple heating water treatment.

Based on the laboratory examination results of drinking water in X Industry canteen. Primary data is obtained on February 25, 2022, resulting in 1.1 MPN / 100 ml meanwhile the required quality standard is 0 MPN/ 100 ml based on the Republic of Indonesia Minister of Health Regulation Number 492 of 2010 on Drinking Water Quality Requirements (Permenkes RI, 2010). Researchers conducted an examination of clean water at X Industry in the Laboratory, resulting in 5.1 MPN/ 100 ml, while the quality standards required is 0 MPN/ 100 ml is based on the Regulation of Republic of Indonesia,

Minister of Health Number 32 of 2017 concerning Environmental Health Quality and Water Health Requirements Standard for Sanitary Hygiene Purposes, Swimming Pools, Solus Per Aqua, and Public Baths the results meet the requirements, therefore the researcher wants to use the clean water sample to be directly used as drinking water by using the Reverse Osmosis membrane filtration process, thus no water heating treatment is needed anymore.

Coliform bacteria are a type of bacteria that is commonly used as an indicator of determining the sanitary quality of food and water(Ashbolt et al., 2001; Feng et al., 2002; Some et al., 2021). Coliform itself is not the cause of waterborne diseases, but this type of bacteria is facile to culture and its presence can be used as an indicator of pathogenic organisms' presence such as other bacteria, viruses or protozoans are parasites that live in the human digestive system and are contained in feces(Hrudey et al., 2003; Pebriadi, 2013; Vendrell & Atilas, 2013).

Reverse Osmosis membrane is a water purification technology that uses semipermeable membranes(Malaeb & Ayoub, 2011; Pérez-González et al., 2012; Subramani & Jacangelo, 2014). Reverse Osmosis systems can separate unwanted components such as organic, non-organic, bacterial, viral, and particulate matter, as well as ions or hook salts(Al-Obaidi et al., 2020; Collentro, 2010). The Reverse Osmosis system is also known as a filter media that has the smallest pore compared to other filters, which is 0.0001 microns(Brown et al., 2008; Ергожин et al., 2019). Reverse Osmosis membrane technology has advantages, including processing can be done continuously, relatively low energy consumption, easy to combine with other separation processes, can be performed under adjustable operating conditions, does not require additives, and varies membrane constituent materials(Jiang et al., 2017; Mardiatin & Purwoto, 2014; Skuse et al., 2021).

Reverse Osmosis membrane can reduce the content of Escherichia coli and Coliform bacteria with a reduced efficiency of 91% which occurs at a pressure of 43 psi(Mardiatin & Purwoto, 2014). Then based on other studies, the optimum Reverse Osmosis performance is at a pressure of 4 bar, and a flow rate of 5.0 L/minutes with the effectiveness of the Reverse Osmosis membrane to reject Escherichia coli

and Coliform as much as 100% (Asmaningrum & Pasaribu, 2016). The results of the descriptive analysis show that the water pressure used is 2, 2.5, and 3 bar on the reverse osmosis membrane that is applied to reduce the number of Escherichia coli bacteria in clean water in the textile industry, all of the pressure variations can reduce Escherichia coli bacteria up to 0 MPN/ 100 ml (Chairunissa et al., 2021).

The explanation above caught the researcher's interest to conduct an experimental study to find out the most effective water pressure on the RO membrane to reduce the total number of Coliform bacteria in the drinking water of canteen X Industry. The study used pressure variations of 1, 1.5 and 2 bar.

## **METHODS**

This research is an experimental study with a pre-test and post-test without a control design. The samples used in this study were clean water and drinking water in the canteen of X Industry will be treated with variations of water pressure, which is at 1, 1.5, and 2 bar. Sampling is carried out using the grab sampling technique.

This study conducted six treatments with three repetitions, where pre-test and post-test were carried out in each treatment and repetition. The pre-test samples were taken from the clean water in X Industry canteen. Then during post-test sampling, a Reverse Osmosis membrane replacement is carried out in every replacement of water pressure variations. The test was carried out in two days with three repetitions per day. The number of samples required in this study was 36 samples.

The data collection tools used include a water thermometer to measure the temperature of drinking water, a TDS meter to measure the TDS drinking water, a pH meter to measure the pH in drinking water, a set of laboratory equipment examination of Total Coliform samples, and cameras. The design of the research tool is shown in Figure 1.

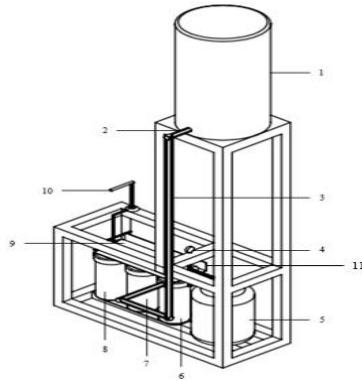

**Figure 1. Research Tool Design**

Description based on Figure 1. Research Design is:

1. Reservoir: To collect water that will enter the Reverse Osmosis membrane tool
2. Faucet on/off: To regulate the water that will enter the membrane Reverse Osmosis
3. 1/4-inch Hose size: To drain water from the reservoir to the sedimentation filter, GAC filter, CTO filter, and Reverse Osmosis membrane.
4. Pressure gauge: To regulate the Reverse Osmosis membrane tool
5. Storage tank: To store water from reverse osmosis membrane filtration
6. Sedimentation filter: This process is to precipitate dirt, mud, sand, and dust
7. Filter GAC (Granular Activated Carbon): Is a filter containing activated carbon in the form of granules or granular, the function of this filter is to absorb odors, tastes, colors, and organic substances in water
8. CTO (Chlorine Taste Odor) Filter: The media on this filter is a block-shaped carbon sheet containing activated carbon, the function of this carbon is to neutralize taste and smell, then to filter chlorine as well as metals in water.
9. RO Membrane: Reverse Osmosis membrane can filter various contents of microorganisms, heavy metals, bacteria, viruses, inorganic materials, and other harmful materials dissolved in water.
10. Outlet faucet: To remove the treated water from the Reverse Osmosis membrane



11. Boost pump: A pump that pushes water from the GAC filter (inlet) to the Reverse Osmosis membrane (outlet).

Univariate analysis is used to find out the mean or average value, the highest value, the lowest value, and standard deviation, as well as the reduction results of measuring the difference in pressure variation on the Reverse Osmosis Membrane and total calculation results of Coliform, pH, Temperature, and TDS. The Bivariate Analysis used is the One-Way ANOVA Test to know the difference of water pressure on the Reverse Osmosis Membrane towards the reduction of total Coliform in drinking water.

## RESEARCH RESULTS

The Total Coliform examination is carried out before and after passing through reverse osmosis membrane filtration, samples that have been taken and then sent to the laboratory for examination.

**Table 1. Results of Total Coliform Content Examination in Drinking Water Before Treatment (Pretest) and After Treatment (Posttest)**

No	Drinking Water Quality Test	Total Colony Count (Colony/100ml)								
		1 Bar			1.5 Bar			2 Bar		
		Pretest	Posttest	Difference	Pretest	Posttest	Difference	Pretest	Posttest	Difference
1	Repetition 1	38	0	38	38	2	36	41	5	36
2	Repetition 2	41	0	41	40	2	38	43	6	37
3	Repetition 3	43	0	43	38	4	34	43	6	37
4	Repetition 4	41	0	41	39	2	37	41	6	35
5	Repetition 5	43	0	43	41	4	37	40	5	35
6	Repetition 6	39	0	39	40	4	36	40	5	35
	<b>Average</b>	41	0	41	41	3	36	41	5	36

Based on Table 1 it is shown that the average result of total coliform content in drinking water before treatment is 41 MPN/ 100 ml. After being treated with variations of water pressure differences, the average result of total Coliform content after a given treatment of 1, 1.5, and 2 bar pressure resulted in 0 MPN/ 100 ml, 3 MPN/ 100 ml, and 5 MPN/ 100 ml, respectively. While the average reduction result of total Coliform content in drinking water at X Industry after being treated with water pressure of 1, 1.5, and 2 resulted in 41 MPN/ 100 ml, 36 MPN/ 100 ml, and 36 MPN/ 100 ml respectively.

**Table 2. Temperature Measurement Results of Drinking Water Before Treatment (Pretest) and After Treatment (Posttest)**

Repetition	Temperature (°C)					
	Pressure					
	1 Bar		1.5 Bar		2 Bar	
	Pre	Post	Pre	Post	Pre	Post
1	27.7	27.7	27.6	27.7	27.1	27.1
2	27.5	27.6	27.7	27.8	27.2	27.3
3	27.5	27.7	27.5	27.6	27.4	27.4
4	28.4	28.5	28.6	28.6	28.2	28.2
5	28.3	28.3	28.5	28.6	28.5	28.6
6	28.5	28.6	28.3	28.5	28.4	28.5
<b>Range</b>	27.5 – 28.5	27.6 – 28.6	27.5 – 28.6	27.6 – 28.6	27.1 – 28.5	27.1 – 28.6

Based on Table 2 it can be seen that the temperature range in the pretest for the first, second, and third treatment which is 1, 1.5, and 2 bar resulted in a temperature range of 27.5 – 28.5 °C, 27.6 – 28.6°C, and 27.5 – 28.6°C, respectively. As for the post-test, the clean water that passed through the Reverse Osmosis membrane for the first, second, and third treatment which is 1, 1.5, and 2 bar resulted in temperature ranging from 27.6 – 28.6°C, 27.1 – 28.5°C, and 27.1 – 28.6°C.

**Table 3. TDS Measurement Results of Drinking Water Before Treatment (Pretest) and After Treatment (Posttest)**

Repetition	TDS (ppm)					
	Pressure					
	1 Bar		1.5 Bar		2 Bar	
	Pre	Post	Pre	Post	Pre	Post
1	355	29	352	25	360	22
2	57	25	358	23	356	23
3	352	27	357	24	362	21
4	354	28	358	25	352	24
5	350	25	351	24	358	25
6	351	30	352	28	364	22
<b>Average</b>	353,166	27,333	358	24,833	358,666	22,833

Based on Table 3 it is shown that the TDS in the first, second, and third treatment, which is 1, 1.5, and 2 bar respectively, resulted in an average TDS for the first treatment of 353.166 ppm for pretest water and 27.333 ppm for posttest water, for the second treatment by 358 ppm for pretest water and 24.833 ppm for posttest water, and as for the third treatment by 358.666 ppm for pretest water and 22.83 ppm for posttest water. The standard deviation of TDS on pretest and posttest in every pressure variation of 1, 1.5, and 2 bar is 39.33 with 42.66, 6.033 with 1.722, and 4.320 with 1.471, respectively.

**Table 4. pH Measurement Results of Drinking Water Before Treatment (Pretest) and After Treatment (Posttest)**

Repetition	pH					
	Pressure					
	1 Bar		1.5 Bar		2 Bar	
	Pre	Post	Pre	Post	Pre	Post
1	7.6	7.1	7.8	7.1	7.6	7.3
2	7.5	7	7.8	7	7.7	7.2
3	7.7	6.9	7.7	7.2	7.5	7.1
4	7.6	7	7.6	7	7.7	7.1
5	7.5	7.1	7.6	6.9	7.5	7
6	7.5	7	7.6	6.8	7.5	7.3
<b>Range</b>	7.5 – 7.7	6.9 – 7.1	7.6 – 7.8	6.8 – 7.2	7.5 – 7.7	7 – 7.3

Based on Table 4, the pH range of the first treatment (1 bar pressure) on pretest water is 7.5 – 7.7, and 6.9 – 7.1 on post-test water, for the second treatment (1.5 bar pressure) on pretest water is 7.6 – 7.8 and 6.8 – 7.2 on posttest water, and for the third treatment (2 bar) on the pretest, water is 7.5 – 7.7 and 7 – 7.3 on posttest water.

#### One-Way ANOVA Test

The One-Way ANOVA test is a parametric test used to compare average values on dependent variables across all compared groups. The One-Way ANOVA test in this study was carried out to determine the difference in water pressure towards the reduction of total Coliform content in drinking water. The results of the One-Way ANOVA test can be seen in the following table:

**Table 5. Bivariate Analysis Results Using One-Way ANOVA Test**

	Asymp. sig
Water Pressure Variations towards Total Coliform Content in Drinking Water using Reverse Osmosis Membrane	0.001

Description:

- If the value of Asymp. sig  $\geq 0.05$  then  $H_0$  is accepted
- If the value of Asymp. sig  $\leq 0.05$  then  $H_0$  is rejected

Table 5 showed the results of bivariate analysis using the One-Way ANOVA test, which resulted in sig  $0.001 \leq \alpha (0.05)$ , thus  $H_0$  was rejected meaning that there was a difference in water pressure towards the total coliform content in drinking water treated using a Reverse Osmosis membrane in the X Industry canteen.

## Post Hoc Test

The Post Hoc test is used to determine whether a group has significant differences over another. The results of the Post Hoc Test can be seen in the table as follows:

**Table 6. Post Hoc Test Results**

Water Pressure Variations		Mean Difference (I-J)	Std. Error	Sig.
<b>1 bar Pressure</b>	1.5 bar Pressure	4.3167*	0.8630	0.001
	2 bar Pressure	4.8000*	0.8630	0.001
<b>1.5 bar Pressure</b>	1 bar Pressure	-4.3167*	0.8630	0.001
	2 bar Pressure	0.4833	0.8630	0.584
<b>2 bar Pressure</b>	1 bar Pressure	-4.8000*	0.8630	0.001
	1.5 bar Pressure	-0.4833	0.8630	0.584

Based on Table 6 the post hoc statistical test result showed that variations in water pressure had an influence on reducing total coliform content. The largest mean difference value shows the most significant pressure variation in reducing total coliform content in drinking water in X Industry, which is at 1 bar pressure.

## DISCUSSION

### 1. Reduction in Total Coliform Content on Drinking Water in X Industry Canteen

The reduced coliform microbiological content in drinking water in PT. X uses Reverse Osmosis membrane filtration with 3 different variations, namely pressure of 1, 1.5, and 2 bar. The total microbiological content of coliform from all three variations in water pressure naturally reduced after being treated with a Reverse Osmosis membrane.

The results of this study show that the most effective percentage reduction is at a pressure of 1 bar with a percentage reduction of 100%, while for a pressure of 1.5 bar, it is 92.85%, and a pressure of 2 bar is 87.19%.

Reduction of total coliform content in drinking water at PT. X can occur because this study used a spiral wound-shaped membrane, this membrane module is in the form of a sheet that is rolled into a tube. The spiral wound module consists of a membrane, mesh paper (or spacers), and a permeate tube. Spacers are used to create flow channels inside the module and ensure an even distribution of the flow. The membrane is attached on three sides and the open side is connected to the central permeate tube, where the membrane sheet is rolled up. Reverse

Osmosis membranes are made of polymers, mostly made of cellulose acetate or composite polyamide-type membranes (Jeong et al., 2007). This module is used in the Reverse Osmosis process because this spiral wound module has a large permeability (Wenten et al., 2014), and has good fouling control if there is no resistance from solid particles. The feed water that entered the spiral wound module usually passes pre-treatment first to remove solid particles to reduce the risk of fouling (Fritzmann et al., 2007; Muthia, 2017; Prihasto et al., 2009)

Treatment using a Reverse Osmosis membrane is a physical process treatment carried out by providing thrust or pressure, holding all ions, releasing pure water, and removing dirty water (Fababuj-Roger et al., 2007). The reverse Osmosis membrane has a pore size of ten thousand microns and can remove organic substances, bacteria, pyrogens, as well as colloids that are retained by pore structures that function as a filter (Eddy, 2013).

## **2. Temperature Towards Total Coliform Reduction in X Industry**

Temperature measurements on pretest water (before treatment) and posttest (after treatment) in X Industry canteen obtained results for pressure 1, 1.5, and 2 bar with a temperature ranging from 27.1 – 28.6 °C. These results are obtained from testing the water temperature which is very volatile, but the pretest water temperature is still included in the optimal temperature before the water enters the Reverse Osmosis membrane and after exiting the Reverse Osmosis membrane the water temperature range result is almost similar to the pretest water temperature result. The optimum temperature for reverse osmosis system operations ranges from 24-29°C. In addition, Coliform as a pathogenic bacteria can multiply at temperatures of 7 °C to 60 °C (Putri & Kurnia, 2018; Spinks et al., 2006). So based on this, the raw water temperature on a pretest in this study is optimum to be passed through the Reverse Osmosis membrane. The temperature of drinking water after passing through the Reverse Osmosis membrane ranges from 27.1 – 28.6, this is inversely proportional to the total breeding of coliform bacteria because at that temperature the total coliform bacteria can still multiply thus fluctuating results are obtained.

## **3. TDS (Total Dissolved Solid) Towards the Reduction of Total Coliform at X Industry**

The results of TDS measurements in this study were carried out at 2 points, namely on pretest water (before being given treatment) and post-test (after being given treatment) in the X Industry canteen, a result for pretest and post-test is obtained for every pressure variation, as for the average result in pretest for 1, 1.5, and 2 bar is 356,61

ppm and 25 ppm for posttest. The results showed a significant reduction in each variation and the largest reduction was found at a pressure of 2 bar with the lowest value of TDS as 21 ppm, this happened because the substances dissolved in water are retained on the Reverse Osmosis membrane thus the water that has passed through the Reverse Osmosis membrane is considered as water of good quality, and water that is suitable for consumption because the lower the Total Dissolved Solid (TDS) value, the purer the water and good quality (Asmaningrum & Pasaribu, 2016).

One of the factors that are very important and determines whether the water is suitable for consumption is the TDS content or the total content of mineral elements in water because the TDS value indicates the substance organic and inorganic content, minerals, and materials dissolved in it (Islam et al., 2017). The TDS capacity of about 5 – 25 ppm in drinking water is very small, but the latest world criteria require an even lower amount of TDS in drinking water. The output of Reverse Osmosis has already met this requirement, and the TDS contained in drinking water in his study still meets the requirements for consumption (Budiyono, 2012).

#### **4. pH Towards the Reduction of Total Coliform in the X Industry Canteen**

The pH value greatly affects the working system of Reverse Osmosis, membranes made of cellulose acetate can only be operated in a small pH range, the pH must be maintained between 4 and 6 (Arora et al., 2004; Escobar et al., 2000). On the other hand, this membrane is resistant to oxidation by chlorine. Thin-film composite membranes can be operated in the high pH range between 3-11, but they are sensitive to the presence of chlorine. pH measurement on pretest water before treatment and posttest after treatment in X Industry canteen for every pressure variation of 1, 1.5, and 2 bar resulted in a pH range of 6.8 – 7.8. The measurement results show that the pH value that enters the Reverse Osmosis system is drinking water with a normal pH range required for the Reverse Osmosis system operation, which is in a range of 6-9, the water that has passed through the Reverse Osmosis membrane has a relatively lower pH compared to the results before treatment at every pressures variation. The high or low pH value of water depends on several factors, namely the condition of the gases in water such as CO<sub>2</sub>, and the concentration of carbonate and bicarbonate salts, the water pH released from the Reverse Osmosis system can reduce because the carbonates and bicarbonates salts in water are retained on the reverse osmosis membrane, therefore the quality of the water released by the Reverse Osmosis system is already in the neutral pH

range, hence the water is suitable for consumption according to the predetermined quality standards, namely at pH ranging from 6.5 – 8.5.

## 5. Research Limitations

The research that has been carried out is still on a pilot project scale, therefore it cannot be applied directly. In this study, researchers did not examine other parameters other than Coliforms such as Fe, Mn, Hardness, Heavy metals, or other microbiological parameters.

## CONCLUSION

Based on the research that has been carried out, the results of the total coliform content before and after passing through the Reverse Osmosis membrane, at a pressure of 1 bar before 40.83 MPN/ 100 ml and after 0 MPN/ 100 ml, at a pressure of 1.5 bar, before 40.83 MPN/100 ml and after 2.81 MPN/100 ml, and lastly at a pressure of 2 bar before 41.3 MPN/100 ml and after 5.3 MPN/100 ml. There is a significant difference between the variation in water pressure of 1 bar, 1.5 bar, and 2 bar to the reduction in the total coliform content in the X Industry Canteen with a p-value of 0.001. The water pressure of 1 bar on the Reverse Osmosis membrane is the most effective pressure in reducing the total coliform content in drinking water at X Industry Canteen with a percentage reduction up to 100%.

## SUGGESTION

For further research, further research needs to be carried out regarding the saturated condition of the Reverse Osmosis membrane in all variations in the filtration process of the coliform total.

## REFERENCES

- Al-Obaidi, M., Kara-Zaitri, C., & Mujtaba, I. M. (2020). Wastewater treatment by reverse osmosis process. CRC Press.
- Arora, M., Maheshwari, R. C., Jain, S. K., & Gupta, A. (2004). Use of membrane technology for potable water production. *Desalination*, 170(2), 105–112.

**Commented [DEF1]:** It's been translated, the revision is complete

- Ashbolt, N. J., Grabow, W. O. K., & Snozzi, M. (2001). Indicators of microbial water quality. *Water Quality: Guidelines, Standards and Health*, 289–316.
- Asmaningrum, H. P., & Pasaribu, Y. P. (2016). Determination of Level of Iron (Fe) and Hardness In Refill Drinking Water In The District Merauke. *Magistra*, 3(2), 95–104.
- Brown, S. L., Leonard, K. M., & Messimer, S. L. (2008). Evaluation of ozone pretreatment on flux parameters of reverse osmosis for surface water treatment. *Ozone: Science and Engineering*, 30(2), 152–164.
- Budiyono, L. B. (2012). The Performance Of Reverse Osmosis Membrane In Water Treatment. *Ilmiah Bidang Ilmu Kerekayasaan*, 29(1), 1–4.
- Chairunissa, A. A., Prasetyo, D., & Mulyadi, E. (2021). Making Demineral Water Using Reverse Osmosis With Effect of Flow and Pressure. *Jurnal Teknik Kimia*, 15(2), 66–72.  
[https://doi.org/10.33005/jurnal\\_tekkim.v15i2.2544](https://doi.org/10.33005/jurnal_tekkim.v15i2.2544)
- Collentro, W. V. (2010). Ion removal by reverse osmosis. *Journal of Validation Technology*, 16(3), 66.
- Eddy, M. (2013). *Wastewater Engineering: Treatment and Reuse*. McGraw-Hill Education.  
[https://books.google.co.id/books?id=\\_WV6CgAAQBAJ](https://books.google.co.id/books?id=_WV6CgAAQBAJ)
- Escobar, I. C., Hong, S., & Randall, A. A. (2000). Removal of assimilable organic carbon and biodegradable dissolved organic carbon by reverse osmosis and nanofiltration membranes. *Journal of Membrane Science*, 175(1), 1–17.
- Fababuj-Roger, M., Mendoza-Roca, J. A., Galiana-Aleixandre, M. V., Bes-Pia, A., Cuartas-Urbe, B., & Iborra-Clar, A. (2007). Reuse of tannery wastewaters by combination of ultrafiltration and reverse osmosis after a conventional physical-chemical treatment. *Desalination*, 204(1–3), 219–226.
- Feng, P., Weagant, S. D., Grant, M. A., Burkhardt, W., Shellfish, M., & Water, B. (2002). BAM: Enumeration of *Escherichia coli* and the Coliform Bacteria. *Bacteriological Analytical Manual*, 13(9), 1–13.
- Fritzmann, C., Löwenberg, J., Wintgens, T., & Melin, T. (2007). State-of-the-art of reverse osmosis desalination. *Desalination*, 216(1–3), 1–76.
- Gadgil, A. (1998). Drinking water in developing countries. *Annual Review of Energy and the Environment*, 23(1), 253–286.
- Hrudey, S. E., Payment, P., Huck, P. M., Gillham, R. W., & Hrudey, E. J. (2003). A fatal waterborne disease



- epidemic in Walkerton, Ontario: comparison with other waterborne outbreaks in the developed world. *Water Science and Technology*, 47(3), 7–14.
- Islam, R., Faysal, S. M., Amin, R., Juliana, F. M., Islam, M. J., Alam, J., Hossain, M. N., & Asaduzzaman, M. (2017). Assessment of pH and total dissolved substances (TDS) in the commercially available bottled drinking water. *IOSR Journal of Nursing and Health Science*, 6(5), 35–40.
- Jeong, B.-H., Hoek, E. M. V., Yan, Y., Subramani, A., Huang, X., Hurwitz, G., Ghosh, A. K., & Jawor, A. (2007). Interfacial polymerization of thin film nanocomposites: a new concept for reverse osmosis membranes. *Journal of Membrane Science*, 294(1–2), 1–7.
- Jiang, S., Li, Y., & Ladewig, B. P. (2017). A review of reverse osmosis membrane fouling and control strategies. *Science of the Total Environment*, 595, 567–583.
- Malaeb, L., & Ayoub, G. M. (2011). Reverse osmosis technology for water treatment: State of the art review. *Desalination*, 267(1), 1–8.
- Mardiati, P., & Purwoto, S. (2014). Reduction of Escherichia coli and Lead in Clean Water Using Reverse Osmosis Membrane . *WAKTU: Jurnal Teknik UNIPA*, 12, 65–70. <https://doi.org/10.36456/waktu.v12i1.840>
- Muthia, E. (2017). Separation Process Using Membrane Technology. In *Journal of Chemical Information and Modeling* (Vol. 53, Issue 9).
- Pebriadi, D. (2013). The Relationship Between River Water Use And The Incidence Of Diarrhea In Families Who Live Around The Kapuas River, Siantan Hilir Village, Pontianak . *Jurnal Mahasiswa PSPD FK Universitas Tanjungpura*, 1–23.
- Pérez-González, A., Urtiaga, A. M., Ibáñez, R., & Ortiz, I. (2012). State of the art and review on the treatment technologies of water reverse osmosis concentrates. *Water Research*, 46(2), 267–283.
- Permenkes RI. (2010). Regulation of the Minister of Health of the Republic of Indonesia No.492/Menkes/Per/IV/2010 About Drinking Water Quality Requirements. In *Peraturan Menteri Kesehatan Republik Indonesia* (p. MENKES).
- Prihasto, N., Liu, Q.-F., & Kim, S.-H. (2009). Pre-treatment strategies for seawater desalination by reverse osmosis system. *Desalination*, 249(1), 308–316.
- Putri, A. M., & Kurnia, P. (2018). Identification of Coliform Bacteria and The Total Mikrobis in Dung-Dung Ice

around Universitas Muhammadiyah Surakarta Campus. *Media Gizi Indonesia*, 13(1), 41.

<https://doi.org/10.20473/mgi.v13i1.41-48>

- Skuse, C., Gallego-Schmid, A., Azapagic, A., & Gorgojo, P. (2021). Can emerging membrane-based desalination technologies replace reverse osmosis? *Desalination*, 500, 114844.
- Some, S., Mondal, R., Mitra, D., Jain, D., Verma, D., & Das, S. (2021). Microbial pollution of water with special reference to coliform bacteria and their nexus with environment. *Energy Nexus*, 1, 100008.
- Spinks, A. T., Dunstan, R. H., Harrison, T., Coombes, P., & Kuczera, G. (2006). Thermal inactivation of water-borne pathogenic and indicator bacteria at sub-boiling temperatures. *Water Research*, 40(6), 1326–1332.
- Subramani, A., & Jacangelo, J. G. (2014). Treatment technologies for reverse osmosis concentrate volume minimization: A review. *Separation and Purification Technology*, 122, 472–489.
- Treacy, J. (2019). Drinking water treatment and challenges in developing countries. *The Relevance of Hygiene to Health in Developing Countries*, 55–77.
- Vendrell, P. F., & Atilas, J. H. (2013). *Household water quality: Coliform bacteria in your water*.
- Wenten, I. G., Khoiruddin, K., & Hakim, A. N. (2014). *Reverse Osmosis*.
- Ергожин, Е. Е., Чалов, Т. К., Бегенова, Б. Е., & Хакимболатова, К. Х. (2019). Semi-Permeable Membranes For Ultra-, Microfiltration And Reverse Osmosis. *Химический Журнал Казахстана*.

## REVISION

Need revision in the reference section, there are still references written in Indonesian

No	Comment	Respons
1	Penentuan Kadar Besi ( Fe ) Dan Kesadahan Pada Air Minum Isi Ulang Di Distrik Merauke	Determination of Level of Iron (Fe) and Hardness In Refill Drinking Water In The District Merauke
2	Pembuatan Air Demineral Menggunakan Membran Reverse Osmosis (Ro) Dengan Pengaruh Debit Dan Tekanan	Making Demineral Water Using Reserve Osmosis With Effect of Flow and Pressure
3	Penurunan Kandungan Bakteri Escherichia Coli Dan Timbal Pada Air Bersih Menggunakan Membran Reverse Osmosis	Reduction of Escherichia coli and Lead in Clean Water Using Reverse Osmosis Membrane
4	Proses Pemisahan Menggunakan Teknologi Membran	Separation Process Using Membrane Technology
5	Hubungan Antara Penggunaan Air Sungai Dan Kejadian Diare Pada Keluarga Yang Bermukim Di Sekitar Sungai Kapuas Kelurahan Siantan Hilir Pontianak	The Relationship Between River Water Use And The Incidence Of Diarrhea In Families Who Live Around The Kapuas River, Siantan Hilir Village, Pontianak
6	Peraturan Menteri Kesehatan Republik Indonesia Nomor 492/Menkes/Per/IV/2010 Tentang Persyaratan Kualitas Air Minum	Regulation of the Minister of Health of the Republic of Indonesia No.492/Menkes/Per/IV/2010 About Drinking Water Quality Requirements
7	Identifikasi Keberadaan Bakteri Coliform Dan Total Mikroba Dalam Es Dung-Dung Di Sekitar Kampus Universitas Muhammadiyah Surakarta	Identification of Coliform Bacteria and The Total Mikrobess in Dung-Dung Ice around Universitas Muhammadiyah Surakarta Campus
8	<i>Osmosis Balik</i>	<i>Reverse Osmosis</i>

## ACCEPTED (24 September 2022)

[Global NEST Journal] New decision has been made Yahoo/Email M... ☆

 **gnest@gnest.org**  
Kepada: Dr. Elanda Fikri Sab, 24 Sep 2022 jam 23.04 ☆

Dear Dr. Elanda Fikri

On behalf of the Global NEST Journal Editorial Office, we thank you for the submission of your manuscript:

Ref No: gnest\_04458  
Title: Total Coliform Reduction in Drinking Water Based on Variations in Reverse Osmosis Membrane Pressure

We are pleased to inform you that your paper has been accepted for publication in Global NEST Journal.

What comes next:  
In order to proceed with the publication of your manuscript, you have to fill the Transfer of Copyright Agreement (TCA) and make sure that you quote the correct paper ID, title, your name and address.  
Please select all the mandatory check boxes; it is necessary to agree with the terms of TCA.

After successfully submitting the TCA, you will be allowed to proceed with the payment of the publication fee for Global NEST Journal. The publication fee is 200 euros.  
There are two ways you can pay: online and offline.  
Online is faster and is performed through a secure network operated by AlphaBank, a Greek bank. We do not keep any records of credit cards or other bank sensitive information on our website and all details kept on our side, are purposed solely for identification and invoicing.  
Offline method is performed via Bank transfer. It is slower and you are suggested to follow the instructions on the payment screen.

You can find the TCA form in the link below and you can continue from there.  
TCA link: <https://journal.gnest.org/node/10494/tca>

In case the link above does not function, you can go to "My papers" (<https://journal.gnest.org/journal/cmp/author>) which is located at the "Author's menu" at the right side of the page.  
In the section my papers you can find the link to the Transfer of Copyright Agreement (TCA) for your accepted paper.

## ARTICLE IN PRESS 27 SEPTEMBER 2022

[Global NEST Journal] Update regarding gnest\_04458 Yahoo/Email M... ☆

 **gnest@gnest.org**  
Kepada: Dr. Elanda Fikri Sel, 27 Sep 2022 jam 21.03 ☆

Dear Dr. Elanda Fikri,  
We are pleased to inform you that we have published your paper titled "Total Coliform Reduction in Drinking Water Based on Variations in Reverse Osmosis Membrane Pressure" to our journal.

You can find the unedited version in our "Articles in press" section at <https://journal.gnest.org/articles-in-press> or download the file directly at [https://journal.gnest.org/sites/default/files/Submissions/gnest\\_04458/gnest\\_04458\\_draft.pdf](https://journal.gnest.org/sites/default/files/Submissions/gnest_04458/gnest_04458_draft.pdf).

Next, we will create an exact copy of your paper but we would like you to inform us in case you spot any flaws - you will be notified by email.

Yours sincerely,  
Global NEST Journal Editorial Office.

.....

## ARTICLE PROOF (16 Oktober 2022)

[Global NEST Journal] Update regarding gnest\_04458 Yahoo/Email M... ☆

 **gnest@gnest.org**  
Kepada: Dr. Elanda Fikri 🖨️ Min, 16 Okt 2022 jam 14:51 ☆

Dear Dr. Elanda Fikri,  
We are pleased to inform you that the proof of your paper titled "Total Coliform Reduction in Drinking Water Based on Variations in Reverse Osmosis Membrane Pressure" is now available online.

You can find the proof in our "Articles in press" section at <https://journal.gnest.org/articles-in-press> or download the file directly at [https://journal.gnest.org/sites/default/files/Submissions/gnest\\_04458/gnest\\_04458\\_proof.pdf](https://journal.gnest.org/sites/default/files/Submissions/gnest_04458/gnest_04458_proof.pdf).

We took time to create an exact copy of your paper but we would like you to inform us in case you spot any flaws. In case you would like to modify your manuscript, please contact us in the following week. For any further question, we are always at your disposal.

Yours sincerely,  
Global NEST Journal Editorial Office.

← ↶ ↷ → ⋮

## ARTICLE PUBLISH (ONLINE) (5 November 2022)

[Global NEST Journal] Update regarding gnest\_04458 Yahoo/Email M... ☆

 **gnest@gnest.org**  
Kepada: Dr. Elanda Fikri 🖨️ Sab, 5 Nov 2022 jam 18:26 ☆

Dear Dr. Elanda Fikri,  
We are pleased to inform you that the published version of your paper titled "Total Coliform Reduction in Drinking Water Based on Variations in Reverse Osmosis Membrane Pressure" is now online.

You can find the published version of the paper at [https://journal.gnest.org/publication/gnest\\_04458](https://journal.gnest.org/publication/gnest_04458) or download the file directly at [https://journal.gnest.org/sites/default/files/Submissions/gnest\\_04458/gnest\\_04458\\_published.pdf](https://journal.gnest.org/sites/default/files/Submissions/gnest_04458/gnest_04458_published.pdf).

If you have any remarks or questions, please, do not hesitate to contact us.

Yours sincerely,  
Global NEST Journal Editorial Office.

← ↶ ↷ → ⋮

[https://journal.gnest.org/publication/gnest\\_04458](https://journal.gnest.org/publication/gnest_04458) 🔍 ☆ 🛡️ 🗑️ 📁 🌐

You are logged in as **Dr. Elanda Fikri** - Logout



# Global NEST Journal

HOME | BROWSE THE JOURNAL | ARTICLES IN PRESS | ONLINE NEWS | ABOUT

## Articles in Press

Volume 25

- ▶ Issue 6 - [In progress]
- ▶ Issue 5 - [May]
- ▶ Issue 4 - [March]
- ▶ Issue 3 - [February]
- ▶ Issue 1 - [January]
- ▶ Issue 2 - [April]

Volume 24

- ▶ Issue 4 - [November]
- ▶ Issue 3 - [October]
- ▶ Issue 2 - [June]
- ▶ Issue 1 - [March]

Volume 23

- ▶ Issue 4 - [December]
- ▶ Issue 3 - [November]
- ▶ Issue 2 - [October]
- ▶ Issue 1 - [June]

Volume 22

- ▶ Issue 4 - [December]
- ▶ Issue 3 - [November]
- ▶ Issue 2 - [July]
- ▶ Issue 1 - [March]

**Total Coliform Reduction in Drinking Water Based on Variations in Reverse Osmosis Membrane Pressure**

**Paper Topic:**  
Water and Wastewater Treatment

---

**Volume:**  
Volume 24

---

**Issue:**  
Issue 4

---

**Pages :**  
569 - 575

**Corresponding Author:**  
Elanda Fikri

---

**Authors:**  
Fikri E. Ramdhanny FM.  
Nurhayati A. Khair ASE

 **Download**

Paper ID:  
gnest\_04458

Paper Status:  
Published

Date Paper Submitted:  
05-09-2022

Date Paper Accepted:  
24-09-2022

Paper online:  
27/09/2022

**DOI:**  
<https://doi.org/10.30955/gnj.004458>

**Reviewer's Menu**

- ▶ My reviews

**Author's Menu**

- ▶ My papers
- ▶ Submit new paper

**Share Global NEST**

**Follow us**

## Total coliform reduction in drinking water based on variations in reverse osmosis membrane pressure

Fikri E.<sup>1,2</sup>, Ramdhanny F.M.<sup>1</sup>, Nurhayati A.<sup>1</sup>, and Amar Sharaf Eldin K.<sup>3</sup>

<sup>1</sup>Department of Environmental Health, Bandung Health Polytechnic, North Cimahi, 40514, Indonesia

<sup>2</sup>Center of Excellence, Bandung Health Polytechnic, Jalan Pajajaran 56, Bandung, 40171, Indonesia

<sup>3</sup>Omdurman Islamic University, Geography Department, Omdurman City, Sudan

Received: 05/09/2022, Accepted: 24/09/2022, Available online: 27/09/2022

\*to whom all correspondence should be addressed: e-mail: elandafikri@yahoo.com

<https://doi.org/10.30955/gnj.004458>

### Graphical abstract

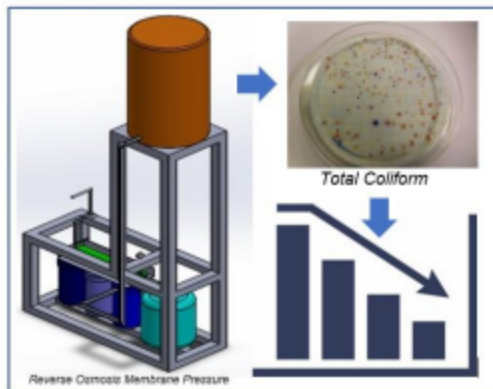

### Abstract

Water is the most important substance. Drinking water in the industry comes from raw water and is treated through a heating process. The results of laboratory tests on raw water used for drinking water are 41 MPN/100ml, so it is necessary to process raw water into drinking water using Reverse Osmosis (RO) membrane technology. The purpose of this study is to determine the difference in the decrease in the total amount of Coliform in drinking water based on variations in water pressure on the Reverse Osmosis membrane in the canteen of X Industry. This type of research is an experiment with the design used is pre-test post-test without control, the sampling technique used is grab sampling, and the total sample is 36 samples with a volume of 3600 ml. The decrease in the total number of Coliforms was analyzed using univariate and bivariate tests. The results of total Coliform in drinking water after treatment with Reverse Osmosis membranes are the average results for a pressure of 1 bar is 0 MPN/100 ml, a pressure of 1.5 bar is 2.81 MPN/100 ml, and a pressure of 2 bar is 5.3 MPN/100 ml. This study concludes that there is a difference between the pressure of 1 bar, 1.5 bar, and 2 bar on the decrease in the total

Coliform content in the canteen of X Industry with a p-value of 0.001, and the most effective pressure to reduce total coliform in drinking water in the canteen of X Industry is a pressure of 1 bar with a 100% percentage. Suggestions for further research to carry out the saturated condition of the Reverse Osmosis membrane.

**Keywords:** Coliform, reverse osmosis membrane, variation of water pressure

### 1. Introduction

Drinking water is household drinking water that goes through a treatment process or without a treatment process that meets health requirements and can be consumed immediately (Gadgil, 1998; Treacy, 2019). Provision of drinking water at X Industry comes from a drilled well, of which there are 4 spots in X Industry and all of them have been licensed and certified. Clean water from the wellbore is drained into the treatment before distribution. Drinking water used in X Industry comes from clean water and only performs simple heating water treatment.

Based on the laboratory examination results of drinking water in X Industry canteen. Primary data is obtained on February 25, 2022, resulting in 1.1 MPN/100 ml meanwhile the required quality standard is 0 MPN/ 100 ml based on the Republic of Indonesia Minister of Health Regulation Number 492 of 2010 on Drinking Water Quality Requirements (Permenkes RI, 2010). Researchers conducted an examination of clean water at X Industry in the Laboratory, resulting in 5.1 MPN/ 100 ml, while the quality standards required is 0 MPN/ 100 ml is based on the Regulation of Republic of Indonesia, Minister of Health Number 32 of 2017 concerning Environmental Health Quality and Water Health Requirements Standard for Sanitary Hygiene Purposes, Swimming Pools, Solus Per Aqua, and Public Baths the results meet the requirements, therefore the researcher wants to use the clean water sample to be directly used as drinking water by using the Reverse Osmosis membrane filtration process, thus no water heating treatment is needed anymore.